

Article number: 0118028

Description: Retaining ring H 13

Measures

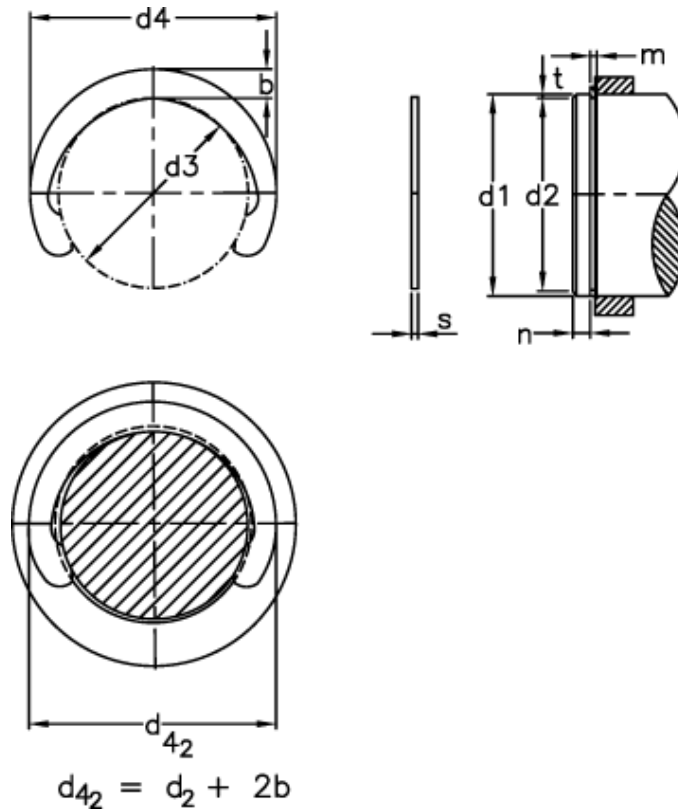

b	= 2.00	FRg kN	= 2.0	t	= 0.60
d1	= 13	FR kN	= 4.50	tol	= -0.11
d2	= 11.8	g	= 1.00	tol	= 0.18
d3	= 11.40	Gripper	= GRH 13	tol	= -0.06
d4	= 15.40	m min	= 1.10	Weight kg/1000	= 0.36
d4 2	= 15.8	n abl x 1000	= 30		
Description	= H 13,0	Nominal drive	= 1.8		
FN kN	= 1.90	s	= 1.00		